



**Portable Air Conditioner  
PAC-15000-A  
Instruction Manual**

ALASKAN

**Before Installing and Operating this Unit ..... Page 2**

**Product Information ..... Page 3**

**Installation Instructions ..... Page 4**

**Installation Instructions ..... Page 5**

**Identification of Parts ..... Page 6**

**Function of the Control Panel ..... Page 7**

**Function of the Remote Control ..... Page 7**

**Model Specification and Safety Cautions ..... Page 8**

**Use of Control Panel ..... Page 9**

**Water Drainage Methods ..... Page 10**

**Air Conditioner Maintenance ..... Page 11**

**End of Season Maintenance ..... Page 11**

**Troubleshooting ..... Page 12**



### **DO**

Please read the Instruction Manual before using this product.

Install the product according to relevant National Wiring Regulations.

Use this product indoors in a dry environment.

Maintain a minimum clearance of 50cm between the back and sides of the unit and any obstruction or wall.

Ensure the areas to the front, sides, rear and above this appliance are not obstructed.

Regularly check the air filter and clean as necessary.

Drain the condensed water from the internal tray as necessary.

### **DO NOT**

**DO NOT** use this appliance outdoors, in bathrooms or in laundry rooms.

**DO NOT** use without a Mains Earth connection.

**DO NOT** block or cover the vents.

**DO NOT** open this appliance – There are no user serviceable parts.

**DO NOT** use this unit without the air filter.

**DO NOT** use this product outside of the published specification.

### **WARNING**

**DO NOT** use if the mains plug, supply cable or appliance becomes damaged. In this event, immediately disconnect from the mains supply.

**DO NOT** reconnect until a qualified engineer has repaired the damage.

This unit is supplied fitted with a UK 13A plug and a BS1362 13A fuse. If a replacement is fitted, the connections are as follows:

Earth – Green/Yellow wire is connected to the E (Earth) terminal sometimes marked Green/Yellow.

Live – Brown wire is connected to the L (Live) terminal sometimes marked Brown.

Neutral – Blue wire is connected to the N (Neutral) terminal sometimes marked Blue.

The plug must only be replaced by a qualified person.

The plug must be rated at 13A or above.

If the plug is of a type that does not contain a fuse, the socket to which it is connected must be rated at 15A and directly protected by a 15A fuse or a 15A circuit breaker.

This product is a portable air conditioner with environmental protection, ease of installation, energy saving and flexible use incorporated into the design.

### **Environmental Protection:**

This product uses R407C as its cooling medium. The contamination index (ODP) to the atmosphere of the R407C is zero, which means it is the one of best environmental protection cooling refrigerants for room air conditioners.

### **Easy Installation:**

As a portable air conditioner, this unit is designed for easy installation. A 13 amp household mains socket provides the power and exhaust air is exhausted via a flexible pipe that can be vented to the outside or other rooms.

### **Energy Saving:**

Compared to split systems the energy use of this unit is much reduced. The principle is that the unit is used to cool or heat relatively small areas at the time required and therefore will save energy.

### **Flexible Usage:**

This unit is portable and is mounted on wheels for convenient transportation between rooms. The flexible hose can vent the heat extracted by the unit in various ways, either permanently fixed or temporary.

### **Functions:**

This unit is designed to cool or dehumidify air. It can also be used as a fan only to circulate room air via the dust filter.

### **Water Condensing:**

This unit has a self-evaporative system. The condensed water is recycled to cool the compressor and save energy. Excess water is collected in an internal tray. If the internal tray is full the water full indicator will light, the buzzer will buzz 10 times every 5 minutes and the unit will automatically stop.

### **Dehumidification (Drying):**

During prolonged periods of dehumidification it may be necessary to remove the drain plug at the rear towards the bottom of the unit and install the drain hose (9mm internal diameter) to a suitable container or drain

### **Air Flow:**

This unit has adjustment for fan speed and either manual or automatic adjustment for airflow direction.

### **Operation:**

This unit can be operated from the control panel located on the unit or a remote control.

### **De-frost:**

The heat pump is equipped with an automatic de-frost function.

### **Safety:**

This appliance is **CE** marked and has been type tested for compliance to the EC EMC and LVD Directives. It is fitted with automatic protection devices, which ensure that the compressor operates safely and effectively.

PAC-15000-A  
ALASKANAIR

## Installation Instructions

### Selection of installation location

This air conditioning unit should not be used in a room that is completely air tight. Consideration should be given to replacement air, since air is pumped out of the room via the flexible exhaust duct. The unit should be installed on a flat dry surface. A minimum clearance of 50cm must be maintained between the rear and sides of the unit and any wall or other obstruction.

(see Diagram 1)

Diagram 1



### Installing the air exhaust duct

#### 1. Temporary installation

Fix the end of the exhaust duct to the exhaust terminal at the rear of the unit. Place the free end of the duct out of a partially opened door or window.

(see Diagram 2)

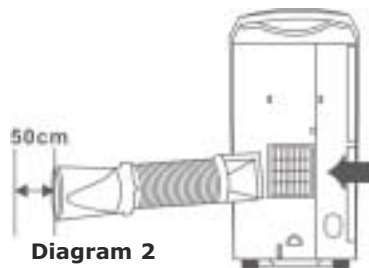

Diagram 2

#### 2. Window kit installation

The window slider kit has been designed to fit most standard vertical or horizontal sash windows. However, it may be necessary to modify some aspects of the installation procedure for some types of sash window. Fix the end of the exhaust duct to the exhaust terminal at the rear of the unit. Fit the rectangular adaptor to the free end of the duct and attach this to the vent hole in the window kit.

(see Diagram 3)

Diagram 3

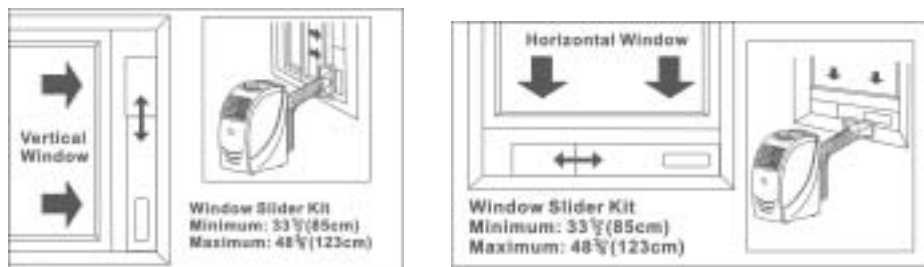

**CAUTION** The window kit must be strongly and safely fixed to the window frame to avoid potential injury from falling parts.

## Installation Instructions

### 3. Permanent Installation

Fix the end of the exhaust duct to the exhaust terminal at the rear of the unit. Drill hole (Ø 120mm) through the wall. Insert and fix the vent ring and cover into the hole. Cover the vent hole with the cap when not in use.

Fit the supplied round adaptor on the air outlet duct then connect it with the vent ring.

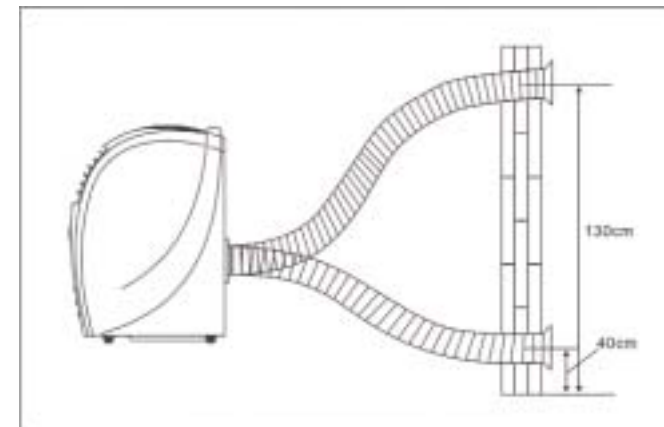

#### Incorrect hose installation.

**Note:** If the exhaust duct is bent too tightly it may cause the unit to malfunction. The maximum height is 130cm and the minimum height is 40cm.

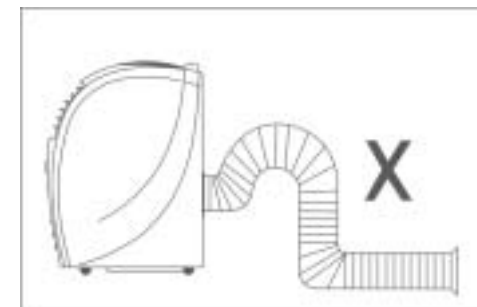

#### WARNING

The length of the exhaust pipe is designed according to the specification of this product. Do not replace or extend it with a longer hose as this could cause mal-function.

The maximum length of the exhaust pipe is 1200mm. Use the shortest possible length. When mounting, we advise to keep the exhaust pipe in a horizontal position. When the vent hole is not in use, use the cap to cover the hole.

## Identification of Parts

### Identification of Parts

1. Control panel
2. Horizontal louver
3. Vertical louver
4. Air inlet grille
5. Castor
6. Exhaust duct
7. Handle
8. Air outlet grille
9. Power cord and plug
10. Water injection port
11. Power cord hook
12. Water level indicator
13. Air filter

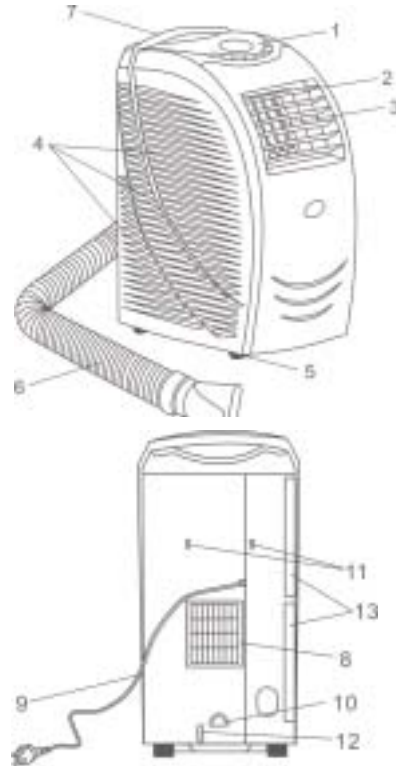

### Accessories

- Flexible exhaust hose with adapters
- Window exhaust adapter (flat mouth)
- Adjustable window slider kit
- Drain pipe

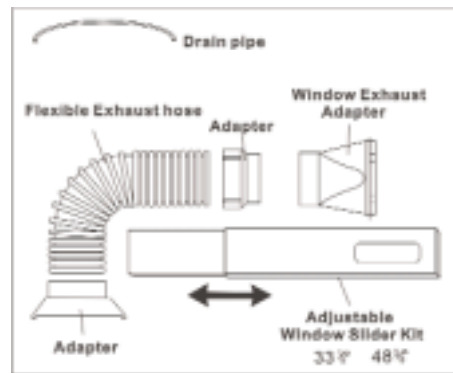

## Control Panel and Remote Control

**NOTE: If the unit is turned off in the Cooling or Dehumidifying mode and restarted immediately, the unit will not restart for approximately 3 minutes.**















### 1. Buttons

- Timer: Press this button to set the timer.
- Swing: Press this button to make the vertical louver swing automatically. Press once again, the swing will stop.
- Speed: Press this button for 5 seconds to select high, medium or low fan speed.
- Up/Down: Press Up or Down button to set temperature or adjust the time in Timer mode. Press both buttons together for at least two seconds to change from Celsius to Fahrenheit.
- Mode: Press this button to select Cool, Dry or Fan mode.
- Econ: Press this button to a set energy saving mode (only in cool mode). The set temperature is 27° in cool mode. The fan speed is low. The LED display will flash or accordingly. Press again to cancel it when or is flashing.
- Power: Press this button to turn the unit on or off.

### 2. LED display

- Timer indicator
- Dry, Cool and Fan mode indicator
- High, Medium and Low fan speed indicator
- Water Full indicator
- Water Injection indicator
- IR receiver window
- Indicate the time and temperature. Display E2, 3, 4 or 5 indicate that there is a fault refer to Self Diagnosis function on page 12). Display E4 is normal when the coil is automatically defrosting.
- Celsius or Fahrenheit indicator

**Remote Control**

-  Power-Press this button to turn the unit on or off.
-  Timer-Press this button to set the timer.
-  Swing-Press this button to make the vertical louver swing automatically.
-  °C°F- Change from Celsius to Fahrenheit.
-  Cool- Press this button to choose Cool mode.
-  Dry- Press this button to choose Dry mode.
-  Fan- Press this button to choose Fan mode.
-  Up- Press Up or Down button to set temperature  
Down- or adjust the time in Timer mode.
-  High- Press this button to select high fan speed.
-  Med- Press this button to select medium fan speed.
-  Low- Press this button to select low fan speed.
-  Econ- Press this button to a set energy saving mode only in Cool mode. The set temperature is 27° in cool mode. The fan speed is low.

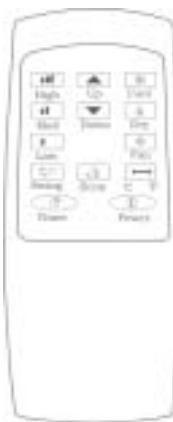

PAC-15000-A ALASKA

<b>Model</b>	<b>PAC-15000-A</b>
Supply Voltage	220-240V AC 50Hz
Rated Current	6.9A
Rated Power Input	1600W
Class I	Mains Earth required
Refrigerant Name	R407C 700g
Cooling Capacity	15000BTU/h
Air Capacity	480 m <sup>3</sup> /h
Noise	<52dB(A)
Weight	39kg
Room Area	30m <sup>2</sup> - 35m <sup>2</sup>
Unit Size	815 X 370 X 595mm
	This appliance is CE marked and has been type tested for compliance to the EC EMC and LVD Directives

**Safety Cautions:**

- Do not** direct the airflow on to pets or animals.
- Do not** place the air conditioner in direct sunlight.
- To avoid electric shocks do not use this unit near water sources.
- To avoid fires do not place this unit near to heat sources such electric fires or gas fires etc.
- Do not** obstruct the flexible exhaust pipe during operation.
- This unit should be used on a level floor.

**1. Set timer-off**

Press the Timer button when the unit is on. The LED will flash the numeric display five times. During this period press Up or Down button to adjust set time from 0.5h to 24h. It will vary 0.5h steps up to 3h and 1h steps thereafter. The set time will flash 5 times after adjusting and will then display temperature. The unit will turn off automatically at the end of the set time.

**2. Change set time**









When Timer is on, you can check the remaining time by pressing the Timer button. The numeric display will flash 5 times. Press Up or Down button to adjust set time. The set time can also be cancelled if you press the Timer button again whilst the display is flashing.

**3. Set timer-on**

Press the Timer button whilst the unit is off. The setting procedure is the same as that for timer-off, above. The unit will turn on automatically at the end of the set time.

**Cooling and Dehumidifying operation**

**1. Cooling operation**

Press Mode button or  /  to select Cool mode. Press Up or Down button or   to set the required room temperature. The range is 18°-30°C(64°-86°F). The temperature will increase or decrease in steps. Press Speed button or    to select the fan speed. Press Swing button or  to select automatic swing of the vertical louver. Adjust horizontal louver by hand.

**2. Dehumidifying operation**

Press Mode button or  to select Dry mode. The fan speed is Low, the LED displays room temperature. These cannot be adjusted.

**NOTE:**

- 1.** In cool mode, when the Water Injection Indicator lights, you should inject some water through the injection port (no higher than the high level).
- 2.** During prolonged periods of dehumidification it may be necessary to remove the drain plug and install the drain hose to a suitable drain or container.
- 3.** Do Not use the exhaust duct in dry or fan mode.

## Water Drainage Methods

This product has a self-evaporative system. The condensing water will recycle to cool the condenser. This improves the cooling efficiency, decreases noise and saves energy.

When in cooling mode, the water from the evaporator will flow into an internal tray. When the water reaches the lower level, an internal pump will recycle the water to cool the compressor.

When the internal water tray is full, the Water Full indicator will light and the compressor will stop working. The buzzer will buzz 10 times every 5 minutes until the water level drops below the high level or is drained. The unit will then work normally after a delay of approximately 3 minutes.

The water can be drained using the drain pipe. It is included in the accessory. Place a container under the drain plug to catch any water whilst affixing the hose

Move the unit gently when the internal water tray contains water to ensure that water does not spill from inside the unit.

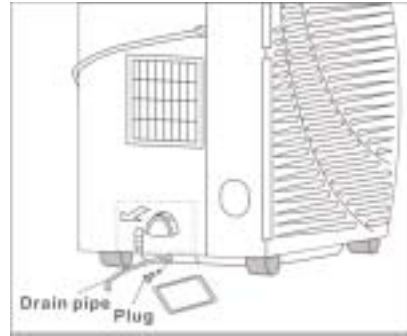

If the internal water level is too low the pump will stop and the Water Injection indicator light. The injection port should be pulled outwards and water poured into it. (No higher than the high level). This will help to save energy.



PAC-15000-A  
ALASKAN

## Maintenance

**Note:** Turn off the unit and unplug it before any maintenance or cleaning, to avoid electric shock.

### 1. Cleaning

Clean the surface of the unit with a soft duster or a soft damp cloth. Do not use chemical solvents like benzene or alcohol etc. These may damage the housing.

### 2. Clean the air filter

If the air filter is blocked with a lot of dust, the efficiency will be impaired. You should clean the filter every two weeks.

A) Pull out the air filter as shown.

B) Wash the air filter by immersing it gently into warm (under 40°C or 104°F) water with neutral detergent. Rinse the filter and dry it in a shaded place.

C) Push the air filter back into the original position.



### End of season

1. Remove the rubber drain plug from the bottom of the unit and drain into a suitable container. You can remove the water entirely by carefully tilting the unit back. After the water is drained select Fan mode and press the Fan button for 5 seconds until the lower fan works. Then operate the unit in fan mode for half a day until the pipe is dry. This dries the inside of the unit thoroughly preventing mildew.

2. Switch off the unit and disconnect the plug from the power supply.

3. Remove the air exhaust duct carefully and pack away.

4. Wrap the unit with a plastic bag, and keep in a dry place.

5. Take the batteries out of the remote control.

## Troubleshooting

Problem	Reasons	Solutions
Air conditioner unit does not operate at all.	<b>1)</b> Is it plugged in? <b>2)</b> Is there power? <b>3)</b> Did the fuse fail or circuit breaker trip? <b>4)</b> Is the LCD display water full indicator on? <b>5)</b> Is the SET TIME correct?	<b>1)</b> Place the plug into the wall socket <b>2)</b> Ensure that the socket is switched on. <b>3)</b> Replace the fuse or reset the circuit breaker <b>4)</b> Drain the water out of the internal water tank. <b>5)</b> Change the SET TIME
Cooling efficiency is poor.	<b>1)</b> Is the air inlet or outlet blocked? <b>2)</b> Is there any other heat source in room? <b>3)</b> Is air filter dirty? <b>4)</b> Is SET TEMP. suitable? <b>5)</b> Is the fan speed set at low?	<b>1)</b> Clear the blockage <b>2)</b> Remove the heat source <b>3)</b> Clean the air filter <b>4)</b> Reset the temperature <b>5)</b> Set a suitable fan speed.
Unit is noisy and vibrating.	<b>1)</b> Is the coolant circulating inside? <b>2)</b> Is the unit on a level floor?	<b>1)</b> This is normal <b>2)</b> Place on a horizontal floor
The unit starts and stops continuously.	<b>1)</b> Is the voltage and rating of the power source correct? <b>2)</b> Is the air exhaust restricted?	<b>1)</b> Refer to the technical specification for the appliance rating. <b>2)</b> Try to keep the air exhaust horizontal and free of tight bends

**Cautions: Switch off and unplug the unit immediately if anything abnormal happens. Then contact a qualified engineer for assistance.**

### Self diagnosis function

Check Code	Diagnosis of malfunction
E2	Room temperature faults
E3	Faulty coil temperature
E4	Compressor coil automatically defrosting
E5	Unit faults (Restart the unit)

PAC-15000-A



InStyle Products Limited.  
 84 High Street,  
 Ware,  
 Hertfordshire,  
 SG12 9AP,  
 UNITED KINGDOM.

Telephone: +44 (0) 1920 463117  
 Facsimile: +44 (0) 1920 462233

email:sales@alaskanaircon.com  
 website: www.alaskanaircon.com